



SS736HF

NISSAN D40 NAVARA ST-X 550
3.0Ltr V6 Intercooled Turbo-Diesel (V9X Engine)
Built: Nissan Motor Iberica, S.A. 2011 onwards



01/05/2013

Parts List

ITEM	PART NO.	DESCRIPTION	QTY
1	430-133-000	BODY - SNORKEL (SS730HF)	1
2	000-135-800	3 ½" AIR RAM ASSEMBLY	1
3	430-032-000	BRACKET - UPPER MOUNTING	1
4	000-002-100	BOLT - HEX - 6mm x 1.0 x 14mm (SEMS)	3
5	000-951-300	SCREW - S/T - 4.2mm x 16mm - S/S	3
6	000-960	INSERT - PLASTIC	3
7	000-110	STUD - 8mm x 1.25 x 25mm - S/S	4
8	000-311-300	WASHER - BODY - 8mm x 30mm - S/S	4
9	000-205-300	NUT - NYLOC - 8mm x 1.25mm - S/S	4
10	430-024-400	HOSE - AIR ENTRY	1
11	430-025-400	PLATE - HOSE SUPPORT	1
12	430-017-400	TEMPLATE - AIR INLET DUCT	1
13	000-958-200	POP RIVET - 4mm x 16mm	10
14	000-300-350	WASHER - BODY 4mm x 12mm	7
15	000-909	CLAMP - HOSE - 80/100mm	1
16	000-914/B	CLAMP - HOSE SIZE 56 (BLACK)	1
17	430-016-000	GASKET - FOAM BODY (SELF ADHESIVE)	1
18	430-017-000	TEMPLATE - GUARD PANEL	1



SS736HF

NISSAN D40 NAVARA ST-X **550**
3.0Ltr V6 Intercooled Turbo-Diesel (V9X Engine)
Built: Nissan Motor Iberica, S.A. 2011 onwards

Installation Guide

Fitment to:

- Left Hand Side

Fitting Time:

- 150min

Special Tools:

- 105mm hole saw
- Pop Rivet Gun
- Step drill
- Masking Tape
- Hacksaw / Body Saw (reciprocating)
- Grinder / Files
- Loctite 243 (thread lock)
- Touch-up paint
- Prep-wash
- 4.5mm Drill Bit
- Sikaflex 227 Adhesive Sealant

Prior to commencing the installation, it is the installer's responsibility to verify that all components and particularly the template (Item 18) are correct.

1

Remove the following in accordance with the factory service manual:

- LHS mud flap
- LHS Inner guard liner
- LHS Indicator lamp (if fitted)
- Engine cover
- Air cleaner assembly
- Air cleaner outlet hose
- Intercooler Hose



2

Tape the guard panel template (item 18) to the rear, upper and lower edges of the left hand guard panel using the indicator hole as a reference point only (some vehicle specifications may not have a guard mounted side indicator fitted).

Ensure that the template is stretched tight to the lower edge of the guard panel. Using a felt tip pen mark all hole positions.

Remove the template.

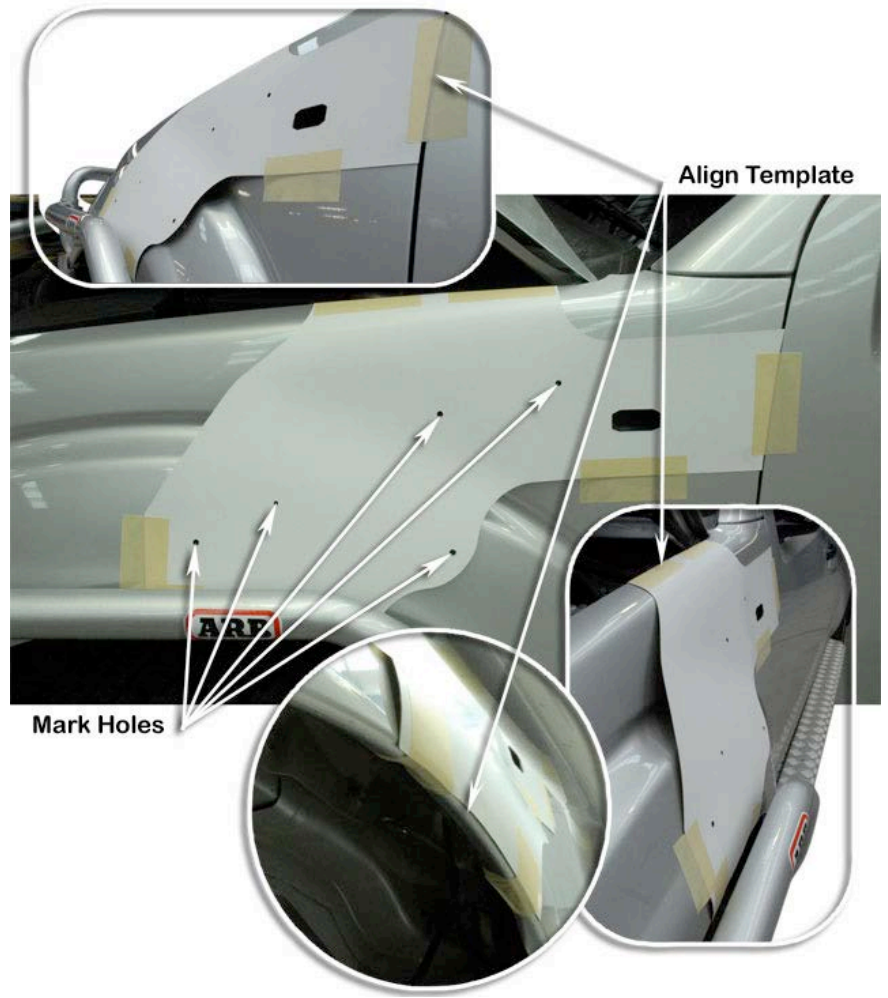

3

Drill a pilot hole for each marked hole position. Using the 105mm hole saw, drill the main hole in the guard panel. Using the step drill, drill the 4 mounting hole positions to 16mm.

Deburr and paint holes to prevent rust.

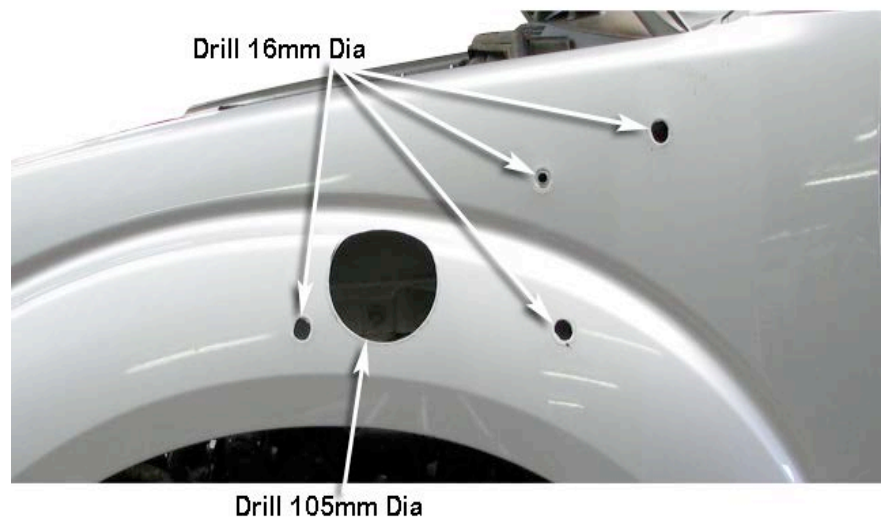

4

Install the upper mounting bracket (item 3) to the snorkel body (item 1) with hex bolts (item 4).

Apply Loctite 243 to each of the stainless steel mounting studs (Item 7) and install the studs finger tight into the snorkel body (item 1) mounting inserts.

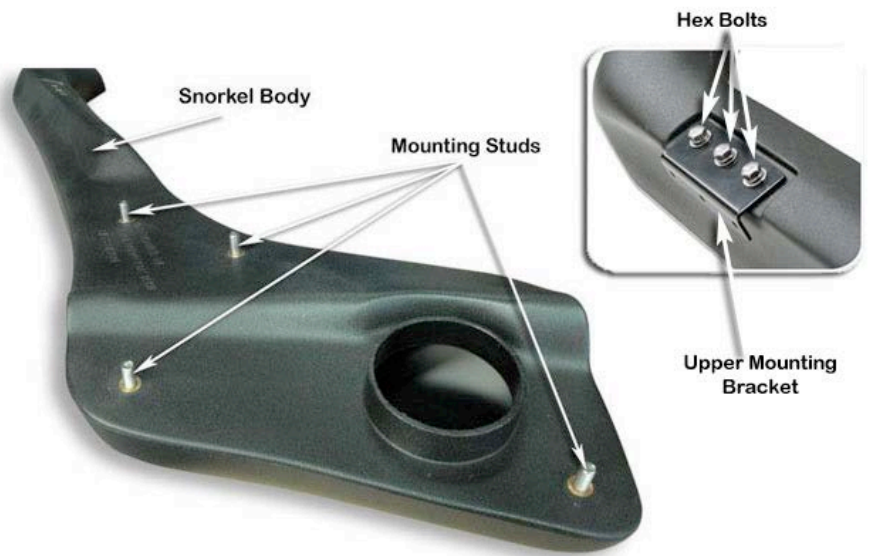

5

Remove the self-adhesive backing paper from the foam body gasket (Item 17).

Carefully align the foam body gasket to the back of the snorkel body (item 1), when correctly positioned, apply firm pressure all over, paying particular attention to the alignment along the top and front edges of the snorkel body.

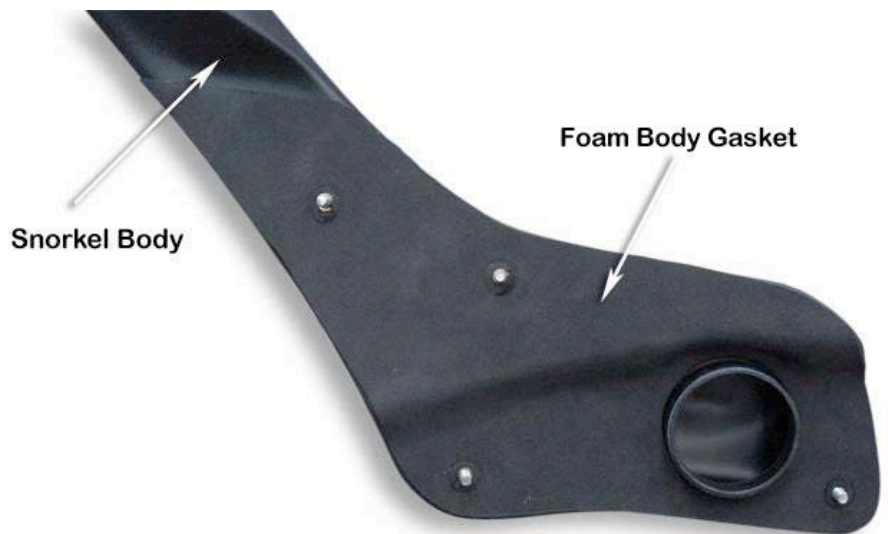

6

Place a strip of masking tape along the 'A' Pillar panel, Carefully install the snorkel body onto the guard panel. Ensure there is adequate clearance around each of the mounting studs.

(If necessary enlarge the 16mm mounting holes to achieve adequate clearance around each of the mounting studs to the guard panel using a round file or die grinder).

7

With the snorkel body correctly positioned onto the guard panel and adequate clearance around each mounting stud, mark the position of the upper mounting bracket (item 3) onto the masking tape as shown.

Remove the snorkel body from the vehicle. Remove the upper mounting bracket from the snorkel body.

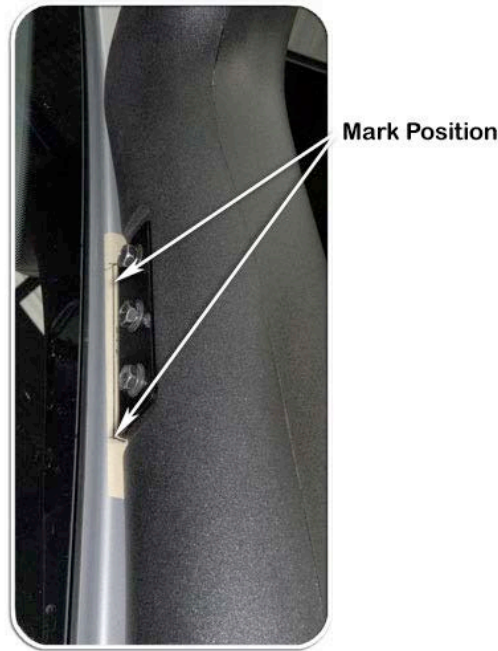

8

Align the upper mounting bracket with the marked position on the 'A' Pillar.

Mark the three mounting hole positions.

Drill a pilot hole at each of the three marked hole positions. Drill each hole position to 8mm diameter with a step drill or 8mm drill bit.

Deburr and paint holes to prevent rust.



9

Install the plastic inserts (Item 6) into the 8mm diameter holes in the A-pillar.

Secure the upper mounting bracket (Item 3) to the A-pillar with three stainless steel self-tapping screws (Item 5).

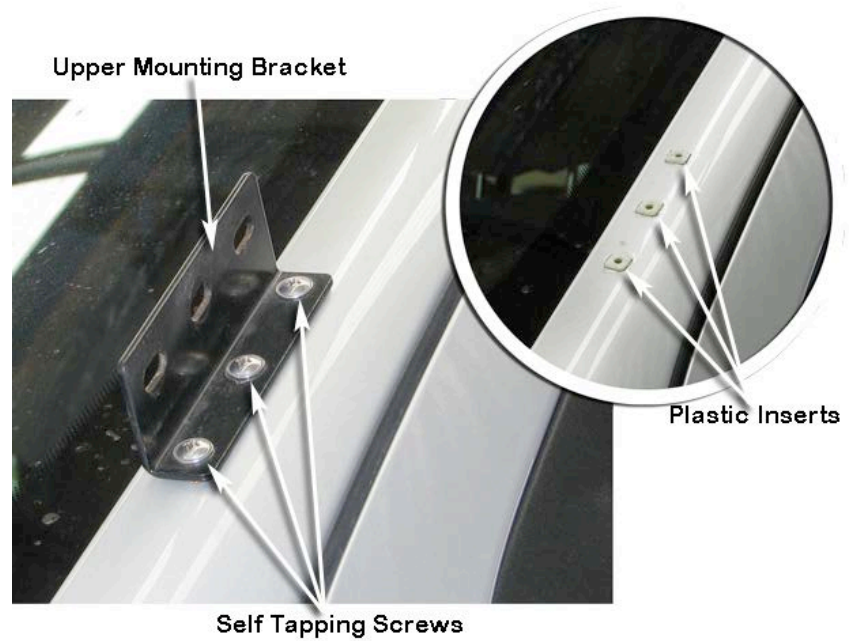

10

Remove the air inlet duct from the air cleaner housing base by rotating the air inlet duct in an anti-clockwise direction.

Remove and discard the foam seal from the air inlet flange.

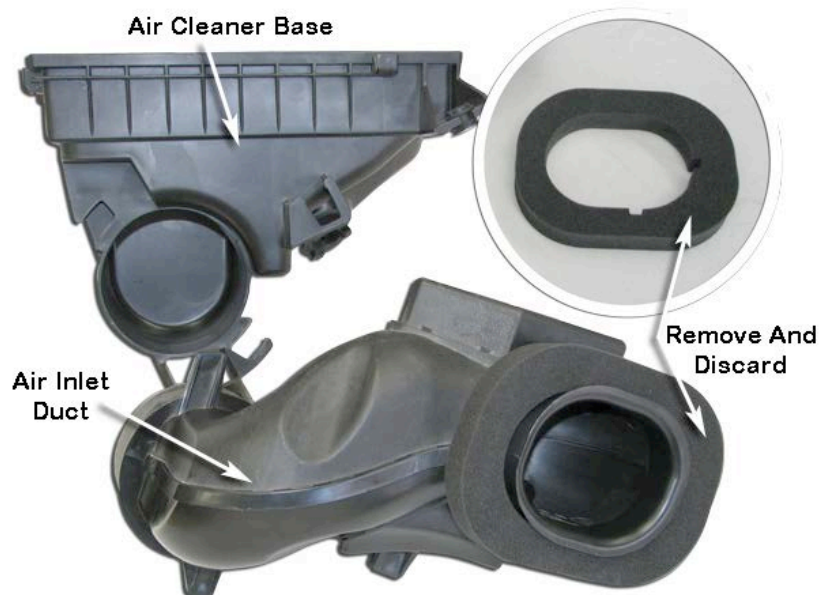

11

Align the air inlet duct template (item 12) to the air inlet duct flange, mark all hole positions and remove the template.

Drill a pilot hole at each of the ten marked hole positions on the flange.

Drill each hole position to 4.5mm diameter.



12

Using the body saw, remove the snout from the air inlet duct as shown.

Using a grinder, grind the snout flush to the flange of the air inlet duct, neaten with a file

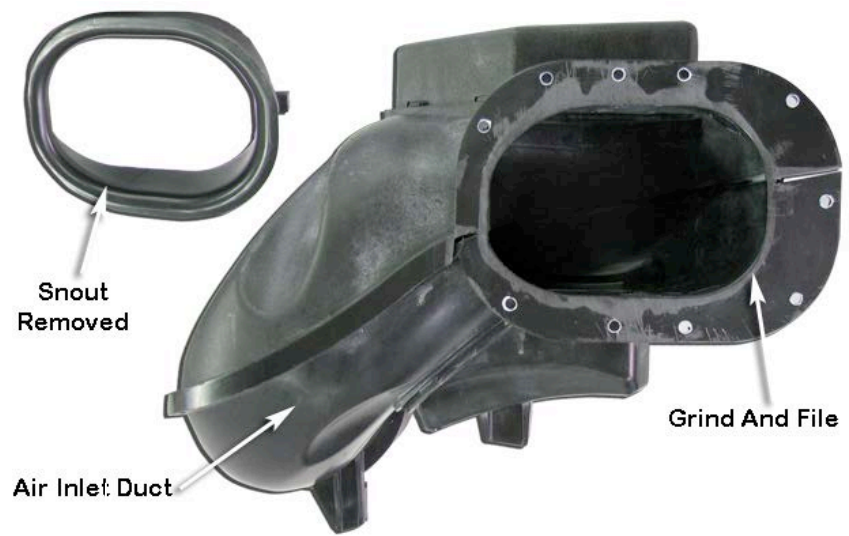

13

Install the hose support plate (item 11) over the air entry hose (item 10) flange, apply a light coating of adhesive sealant to the mating surfaces of the air inlet duct and air entry hose flanges.

Install the air entry hose to the air inlet duct, install all ten pop rivets (item 13) into position. Note the orientation of three pop rivets, install a 4mm body washer (item 14) onto the rear side of the remaining seven pop rivets to prevent the plastic flange from splitting, *(the three pop rivets installed from the plastic flange side through the metal plate do not require a 4mm body washer installed).*

When all of the pop rivets and body washers are in place and the hose is correctly aligned to the air inlet duct, work from the centre outwards and fasten the pop rivets with a pop rivet gun.

Clean-up any excess sealant to ensure a neat finish.



14

The air inlet duct is a two piece part which must be sealed correctly to prevent water from entering the air intake of the vehicle. Apply a generous amount of adhesive sealant to the joints, upper and lower chambers of the air inlet duct, ensure the duct is completely sealed.

Clean-up any excess sealant to ensure a neat finish.

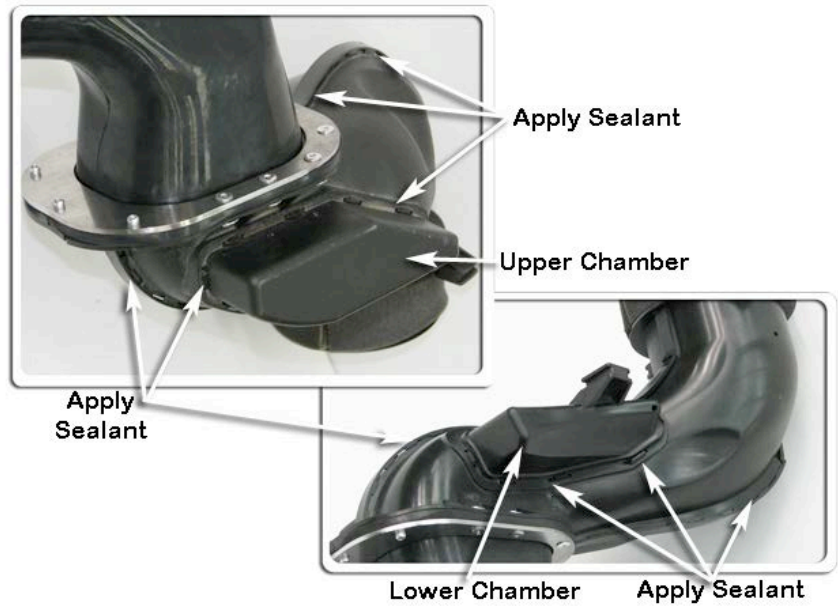

15

Apply adhesive sealant to the air cleaner base inlet and the mating surface of the air inlet duct, install the duct back into the air cleaner base, and ensure the duct locks back into position correctly.

Clean-up any excess sealant to ensure a neat finish.

Remove the rubber mounting grommet shown from the air cleaner base, clean and apply sealant to the grommet.

Refit grommet, clean-up any excess sealant.

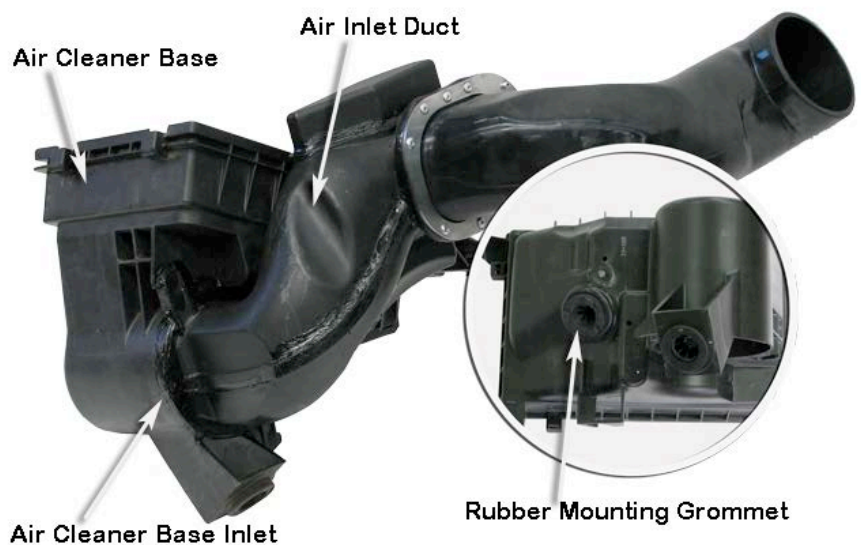

16

INSTALLER OPTION

The air cleaner housing base and air inlet duct contain a number of small drain holes as shown. These holes can permit water to enter the air intake.

It is up to the installer to decide whether the drain holes should be sealed.

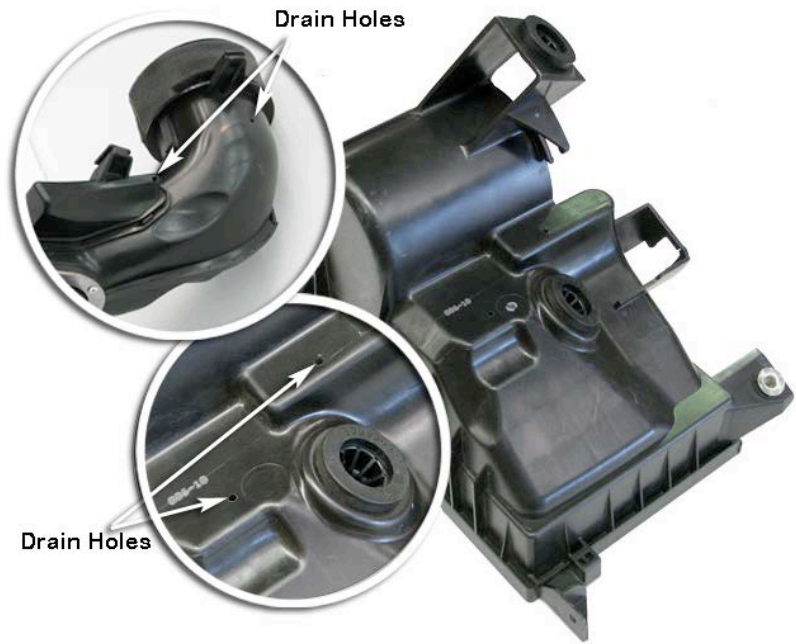

17

Apply CRC 5.56 multi-purpose lubricant or similar lubricant to the outer surface of the air entry hose (item 10).

Install the air cleaner base / air entry hose assembly back into the vehicle, guiding the air entry hose through the hole in the inner guard panel as shown.

Rotate the assembly towards the front of the vehicle until the hose is completely through.

Locate the air cleaner base onto the two standard mounting pins, fasten the air cleaner base with standard mounting bolt.

Install the air filter element, air cleaner housing top and connect the air mass sensor wiring etc.

Install the intercooler hose, air cleaner outlet hose and refit the engine cover.



18

Install the 80/100mm hose clamp (item 15) loosely over the air entry hose (item 10).

Ensure the inside of the hose is completely free of lubricant from the previous step.



19

Carefully install the snorkel body (item 1) to the guard panel, guiding the snorkel body outlet snout into the air entry hose (item 10), align the snorkel body to the guard panel and upper mounting bracket.

When correctly aligned, fasten the snorkel body to the guard panel with body washers (item 8) and nyloc nuts (item 9).

Fasten the snorkel body to the upper mounting bracket with hex bolts (item 4).

Ensure the air entry hose (item 10) is correctly installed onto the snorkel body outlet snout and tighten the 80/100mm hose clamp (item 15).

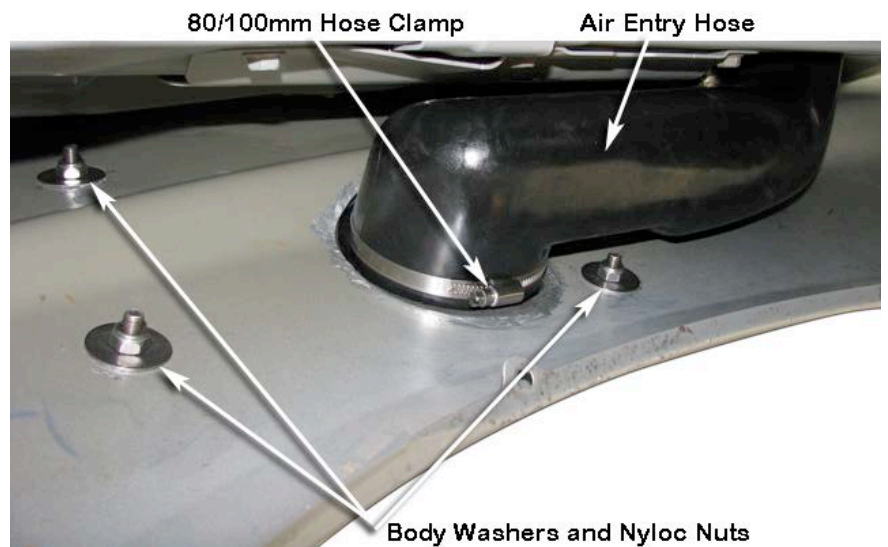

20

Install the black hose clamp (item 16) loosely over the base of the air ram assembly (item 2). Install the air ram assembly onto the snorkel body.

Align the air ram assembly and tighten the black hose clamp (item 16).



21

Reinstall the LHS indicator lamp (if fitted), inner guard liner, mud flap and any other items that may have been removed during the snorkel installation process. Road test vehicle.

22

N.B: It is the installer's responsibility to ensure that all connections are water tight.